

# SOLUTION



Digital AC Servo Press

## SDEiIII/SDEWiIII

SERIES

SDE-8018i3 / SDE-1120i3 / SDE-1522i3 / SDE-2025i3 / SDE-3030i3 / SDEW-2025i3 / SDEW-3025i3

Press



# Announcing The Newly Released 3rd Generation Servo Press Series i3

The newly developed "i3" control system offers the ability to achieve high-accuracy forming with improved productivity.

Supports high value-added motion paths



2019

**SDE i3 / SDEW i3** SERIES



2012



2005



# New Technology of SDE-i3 / SDEW-i3 Series

## 1 "DSDD\*" Servo motor dedicated to DSDD plus crank mechanism

\*DSDD: Digital Servo Direct Drive

Fusion of servo motor for stamping press machine and proven crank mechanism



High-performance control realizes unprecedented high-quality forming.

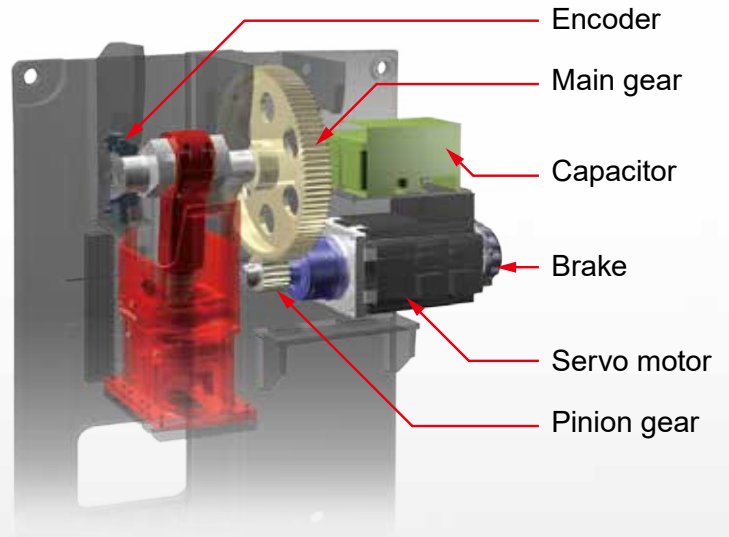

### Improved operability

Operation control panel



The layout has been redesigned, improving operability.

Swivel Pendant control panel

The pendant control panel, with a 12.1" wide screen, can be rotated to improve visibility and operability.



### Stable, high-quality forming

Compared to flywheel-equipped machines, the SDE-i3 Series, which is driven by a servo motor, can secure working energy in the low speed range, achieving stable, high-quality forming.

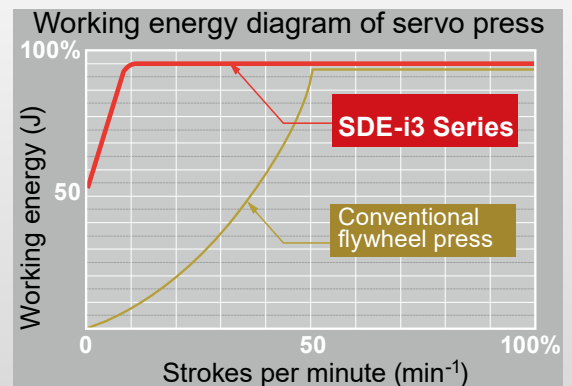

# New Technology of SDE-i3 / SDEW-i3 Series

## 2 High value-added forming and improved productivity

### Twelve kinds of motions

By selecting the most optimal motion path according to the product, it is possible to improve formability, accuracy, and reduce cost.

Attached motions:

Crank, link, soft, program, pendulum, high-speed pendulum, coining, repeat, pulse 1\*, pulse 2\*, pulse 1 pendulum\*, pulse 2 pendulum\*

### Unique pulse forming function

#### Pulse 1 motion\*:

The force is applied to the part while moving the slide up and down (a maximum of 200 times in a single process).

#### Pulse 2 motion\*:

The force is applied to the part while changing the slide lowering speed.

\*Optional for SDEW-i3 models

Sample motion screen



Motion edit screen



### Simple Selectable Motion Programming (SSMP)

- The new standard process sample programming, along with motion sample programming and motion editing, makes the i3 control significantly more simple and easy to program, even for less experienced users.
- High-speed pendulum motion is included as a standard feature. Productivity improved 2 to 7%\*1 compared to the conventional high-speed pendulum motion.
- Pulse 1 and 2 pendulum motions\*2 are included as standard features. Productivity is added to high-value forming.

Processing sample screen

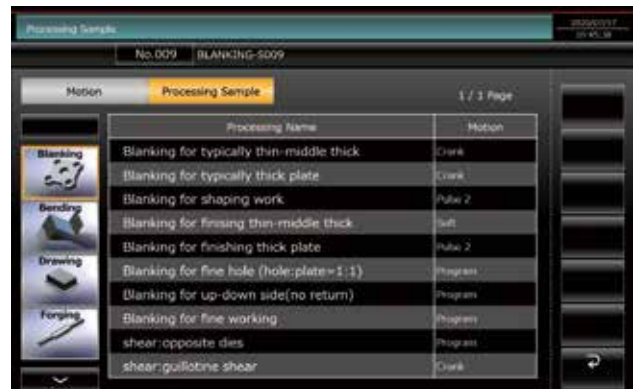

\*1 Depends on the models and conditions

\*2 Optional for SDEW-i3 models

### 3 Newly developed i3 control

#### New original servo controller

The operator interface is greatly improved with the newly designed 3rd generation servo control. It realizes the high-precision and flexible movement unique to a servo stamping press and can handle various types of applications. In terms of operation,

it is easier to use and more visible than conventional machines, contributing to processing, quality, and visualization. In addition, a safety PLC (ISO19062, ISO13892 PLe category 4 compatible) has been added for equipment monitoring along with multi-lingual capability (optional).

#### Improved operability of the screen

Three types of basic operation mode screens are provided for ease of use. Verifying the necessary

information in each operation mode can be done quickly and easily.

##### 1. Production



This screen displays the information necessary for producing the product.

The current values of total counters 1 and 2 and preset counters 1 and 2 can be displayed simultaneously.

In addition, it is possible to monitor changes in load and temperature over time, which are directly related to product accuracy and quality.

##### 2. Trial

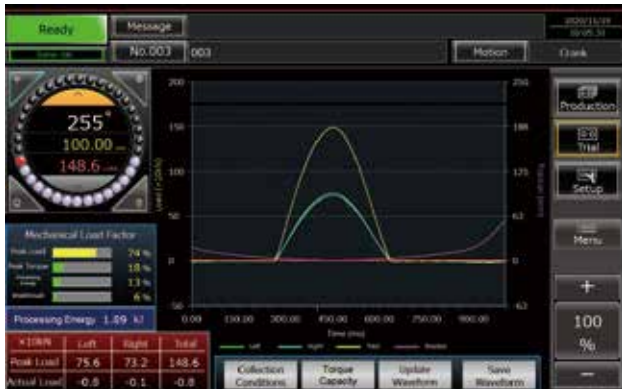

This screen displays the information necessary for trial production that repeats trial hitting, evaluation, and setting.

The load waveform, torque waveform curve, machine load factor, etc., can be monitored.

##### 3. Setup



This screen displays comprehensive information for die setting, etc.

The operator can adjust the die height by utilizing the automatic slide adjustment function, monitor pneumatic equipment, control the digital die cushion,\* and operate the Quick Die Change\* system, all on one screen.

\*Optional

# New Technology of SDE-i3 / SDEW-i3 Series

## 4 Improved quality and productivity

### Built-in color graph load/torque monitor as standard equipment

Each i3 control is equipped with the enhanced load/torque monitoring system, which is more advanced than your normal tonnage monitor.

With the touch of the screen, the operator can simply toggle between operating tonnage and machine torque usage.

The operator can also touch the screen to display the load/position and zoom in and out, allowing them to closely analyze the complete waveform.

### Curve diagram display of torque waveform



### Improved quality control

Digital pressure gauge is used for pneumatic equipment.

The optimum set pressure of the counter balancer (CBC pressure) is displayed according to the upper die mass (input setting).

In addition, it is possible to confirm changes over time such as peak load and ambient temperature, which can be expected to improve accuracy and quality control.

### Display of CBC pressure



### Display of peak load transition

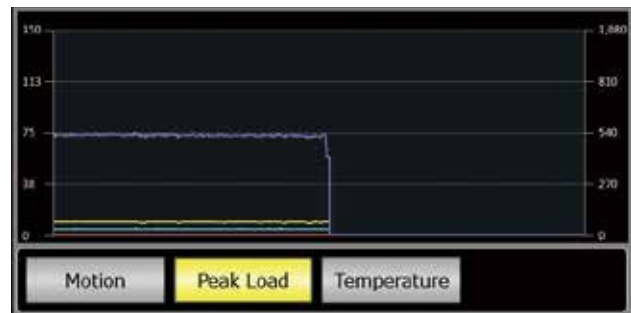

## 5 Reduction in setup time

### Automatic slide adjustment as standard equipment

The automatic slide adjustment functions allows the operator to adjust the die height according to a previously programmed job memory setting.

This reduces setup time and eliminates the chance of inputting the wrong setting.

### Display of automatic slide adjustment



## 6 "MF Eco machines" with environmental consideration

### AMADA's servo press machines are the first MF Eco machine-certified

AMADA's servo press machines were certified by the Japan Forming Machinery Association as MF Eco machines, or environmentally conscious

products, which contribute to environmental impact reduction and working environment improvement.



#### 1 Power conservation: Sharp reduction of power consumption

The power load-leveling, energy-saving circuit of the servo presses sharply reduced their power consumption as compared with conventional

machines. It contributes to the visualization of power consumption.

Power consumption

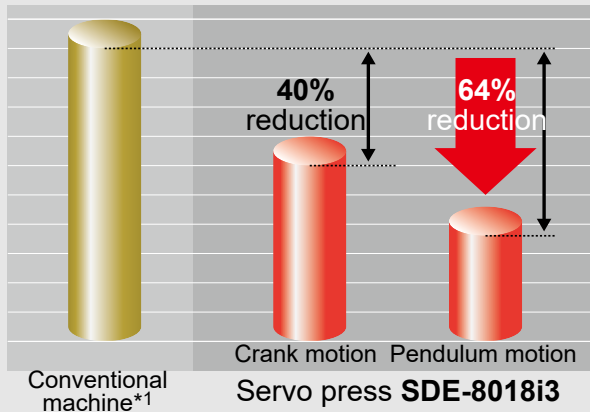

ECO monitor screen



#### 2 Resource conservation: Reduction of lubricating oil consumption

Lubricant consumption is reduced by 67%\*2 compared to conventional machines\*1 by abolishing oil pans and adopting a circulating oil lubrication system. \*2 Compared with SDEW-3025i3

#### 3 Working environment: Significant reduction of stamping noise

Optimum slide motions help to cut the high decibel range of stamping noise. This reduces noise generation and improves the working environment.

\*1 Mechanical stamping press machine of the same class

## Other Functions

### Digital die cushion \*optional

The pressure of the die cushion can be automatically adjusted on the Setup Screen by selecting a previously programmed job memory.

Display of digital die cushion

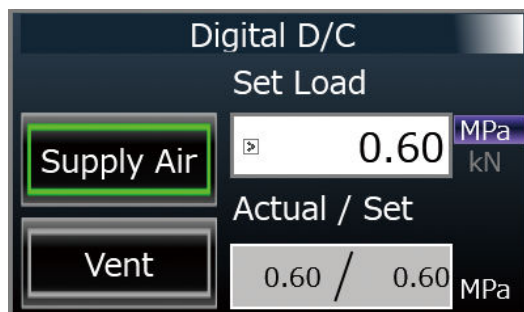

### Built-in die protection system

- 4ch sensor input detection mode: Touch, contact, feed-failure, grip-failure detection
- Settings can be selected on the setup screen by selecting a previously programmed job memory.
- Equipped with a history function dedicated to the built-in die protection system.

Display of die protection system



# Other Functions

## System Automation

### Coil handling system

Complete turn-key systems with the press and coil handling equipment, designed by the same manufacturer, to meet your specific application.

#### Uncoiler

The variable speed of the inverter allows for a gentle start and stop. Prevents the coil from loosening and reduces scratches.

#### Straightener

11 work rolls improve material flatness and contribute to leveling reliability. It is also easy to maintain.

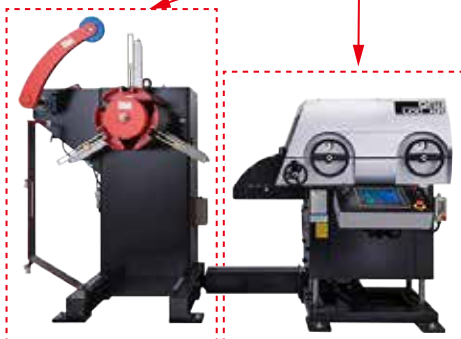

Straightener-Feeder LCC03KR3



SDE-2025i3 + LCC03KR3

## Network-compatible stamping press machines

### Visualization of stamping press operation status and maintenance information by PC

- Digital network connection is possible from general-purpose to servo presses.

- Real-time monitoring of presses connected to the factory network.

- Alarm and maintenance information can be checked and saved in real-time.

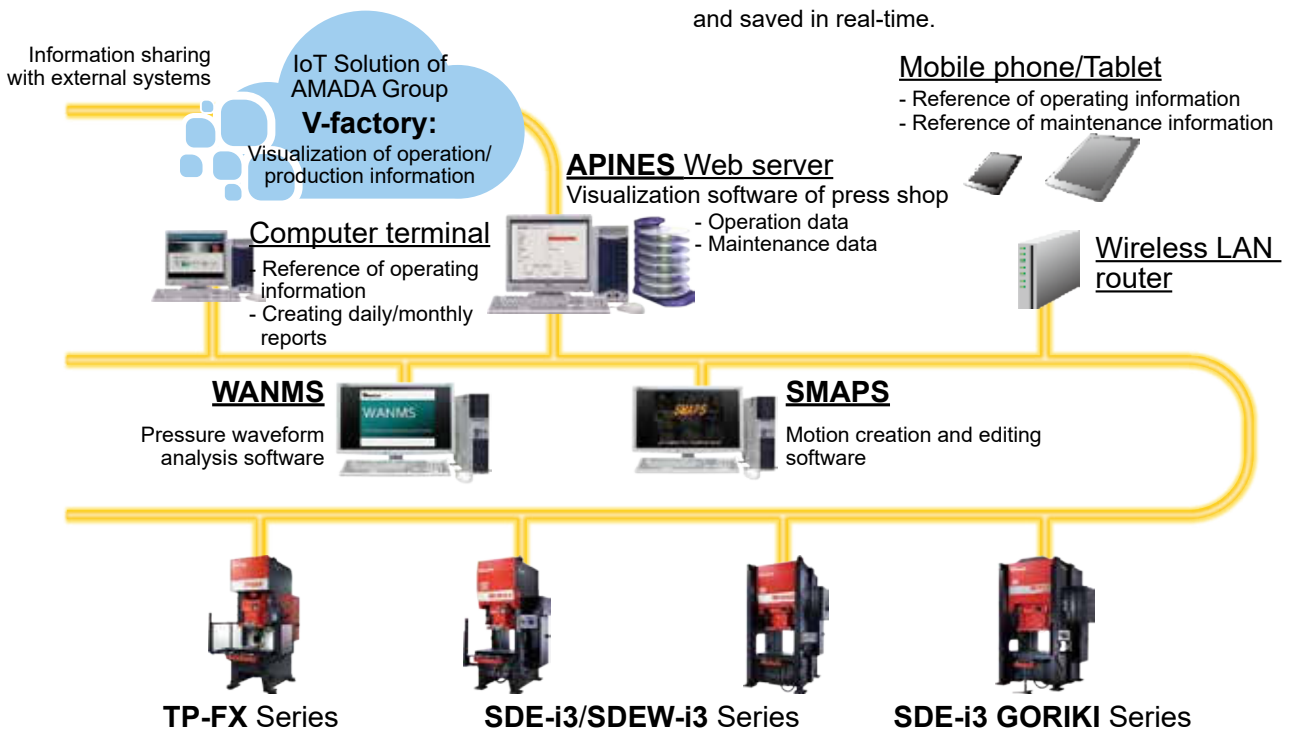

### Network-compatible stamping press machines



# Processing Examples with Sample Workpieces

## Noise and vibration reduction

Machine: **SDE-2025 (SF)**  
 Material: General structural rolled steel  
 (JIS: SS400)  
 Thickness: 0.39"  
 Size:  $\phi$ 1.96"

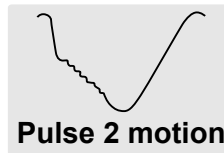

**SDE Series**

Servo presses "SDE Series" can close to target die clearance through reducing punching speed. As a result, noise can be prevented and a shear surface of 100% is achieved.



**Conventional machine\***

The conventional machine has a loud punching sound and the working environment is poor.

\* Mechanical stamping press machine of the same class

## High-accuracy processing

Machine: **SDE-2025 (SF)**  
 Material: High-tensile strength steel  
 Thickness: 0.078"  
 Size:  $\phi$ 0.688" x 2.086"

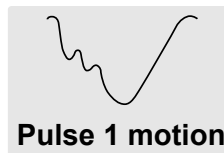

Sample workpieces supplied by Sakaguchi Seisakusyo Co. Ltd.



**SDE Series**

The servo press machine "SDE Series" can form the part without cracking to the last step by the pulse 1 motion profile.



**Conventional machine\***

The conventional machine cracked the part in the final step.

\* Mechanical stamping press machine of the same class

# Processing Examples with Sample Workpieces

## Construction method conversion and high-precision processing

Machine: **SDE-2025i3 (SF)**

Material: Low carbon steel

(JIS: S10C)



Before processing

Size:

ø0.69" x ø0.36" x 1.01"

After processing

Size:

ø0.91" x ø0.27" x 0.66"

Fluid is injected into the center of the material and formed while the fluid is sealed.

This is an example of forging helical gears using internal pressure.

The amount of fluid inside is controlled by "pulse 1 operation" that moves the slide up and down.

As a result, we have developed a fluid pulse forging method (liquid sealing pulse forging method).

The pitch accuracy of the tooth profile part is higher than the gear cutting accuracy by cutting.

## High-precision processing and process reduction

Machine: **SDEW-2025 (SF)**

Material: High corrosion-resistant  
galvanized steel sheet

Thickness: 0.07"

Size: ø3.42" x 2.03"

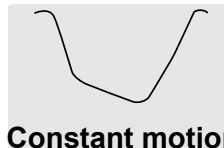

Sample workpieces supplied by DENSO CORPORATION

This is an example of a motor-case part for automobiles.

Conventionally, the process mainly for large transfer stamping press machine with 900 short ton has been realized by only one servo stamping press machine with 220 short ton by the die circulation press processing system configuration.

The conventional 16 processes can be divided into 4 parts (drawing, ironing, trimming, inner diameter forming), and 4 sets of dies can be used to form with the optimum slide motion for each process.

As a result of achieving high-precision processing with an inner diameter accuracy  $\pm 10 \mu\text{m}$  ( $\pm 0.0004''$ ), cutting and plating processes are no longer required.

## Improved forming quality and high-quality processing

Machine: **SDE-3030 (SF)**  
 Material: Aluminum (JIS: A1100)  
 Thickness: 0.31"  
 Size (W x H): 0.04" x 1.28"



Heat sink parts

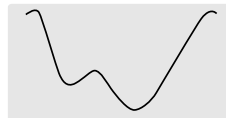

**Program motion**

This is an example of an aluminum heat sink made by extrusion forging by a servo stamping press machine.

The optimum slide motion improved the material flow during forming and realizes load reduction.

By controlling the processing oil and slide moment, it suppresses the processing scratches on heat sink parts.

## Construction method conversion and high-precision processing

Machine: **SDE-2025 (SF)**  
 Material: Aluminum (JIS: A1100)  
 Size:  $\varnothing$ 0.98" x 0.70"



Sample workpieces supplied by Takahashi Industries Co., Ltd.

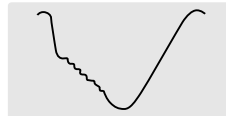

**Pulse 2 motion**

Created a reflector for high-brightness LED lighting only by cold forging with a servo stamping press machine.

A high reflectance within Sa 0.03  $\mu$ m in surface roughness was achieved without aluminum vapor deposition plating.

Compared to conventional resin and aluminum vapor deposited products, this environmentally friendly process achieves high-brightness, high-quality, high-heat dissipation, and high-durability.

# Dimension Tables for Die Space

## ■ SDE-i3 Series

### SDE-8018i3

### SDE-1120i3

### SDE-1522i3

#### Standard slide bottom drawing

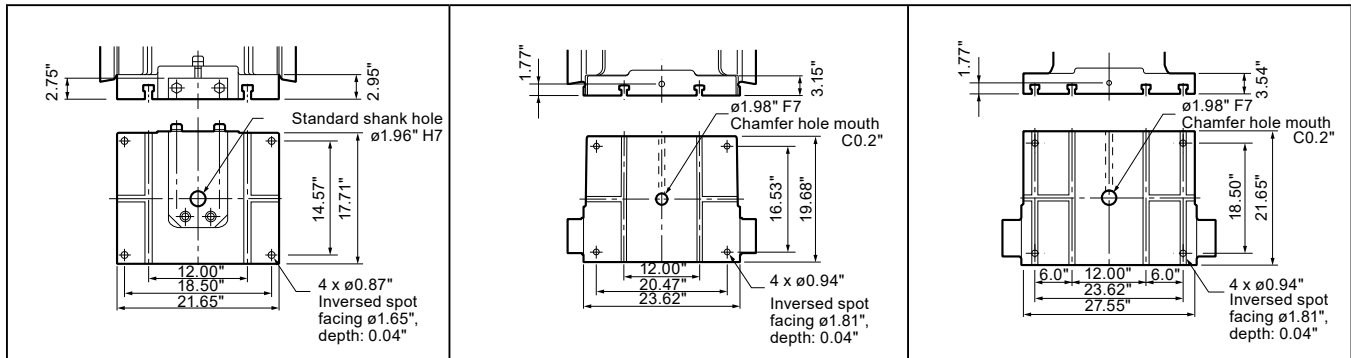

#### Bolster plate drawing

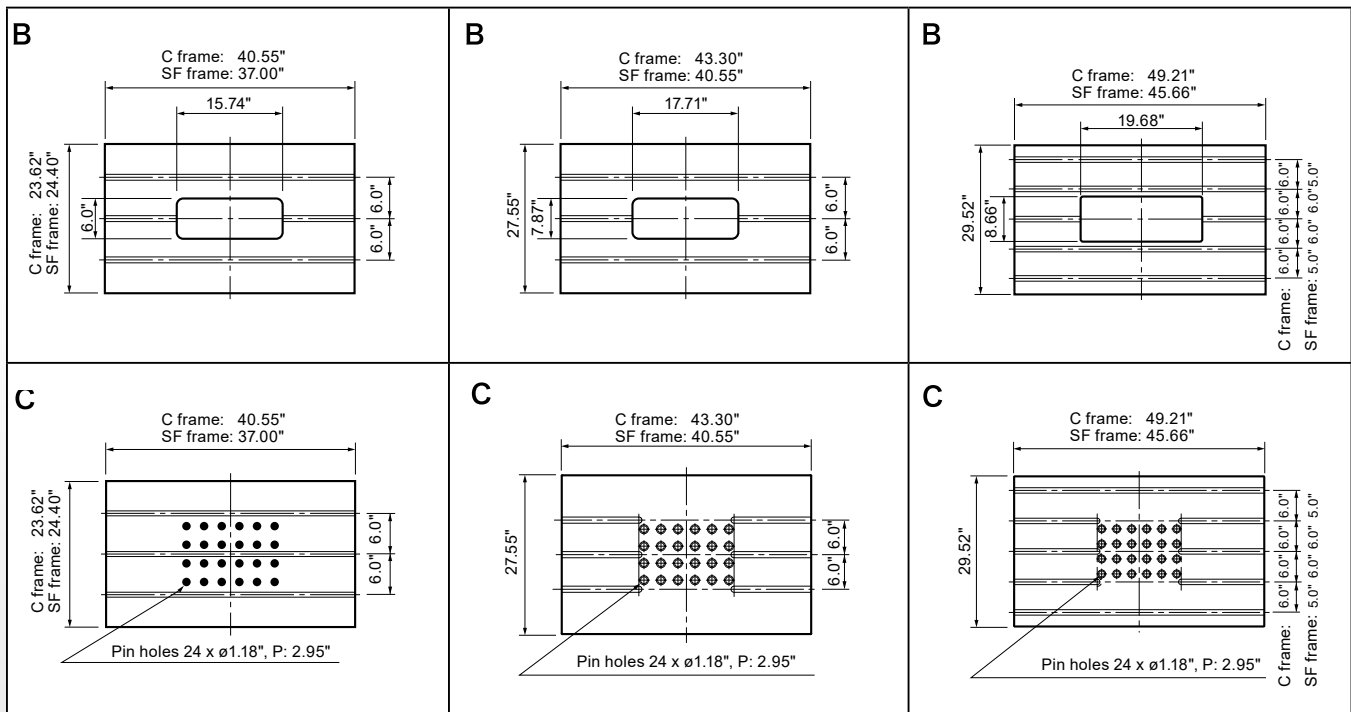

#### T-slot details (common)

#### Cushion pin hole details

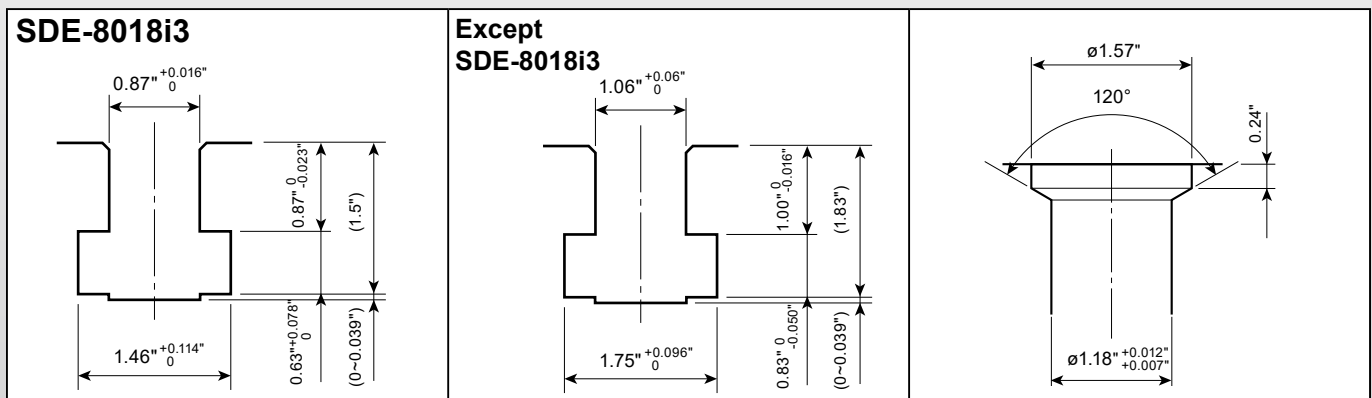

**SDE-2025i3**

**SDE-3030i3**

**SDEW-2025i3**

Standard slide bottom drawing

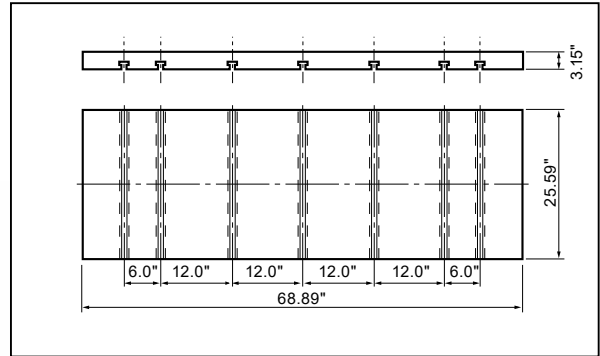
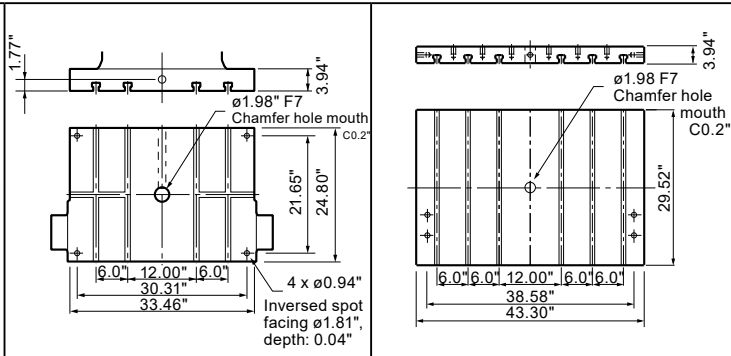

Bolster plate drawing

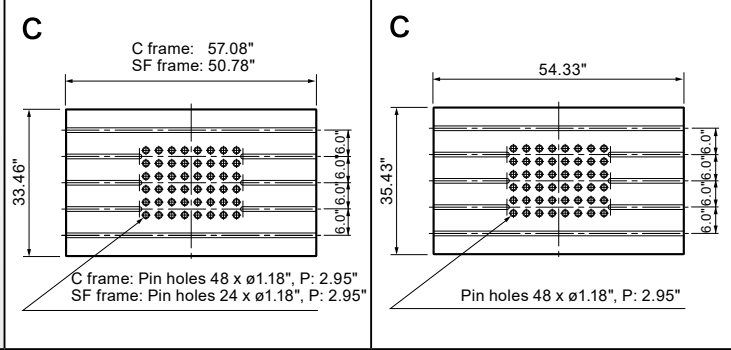
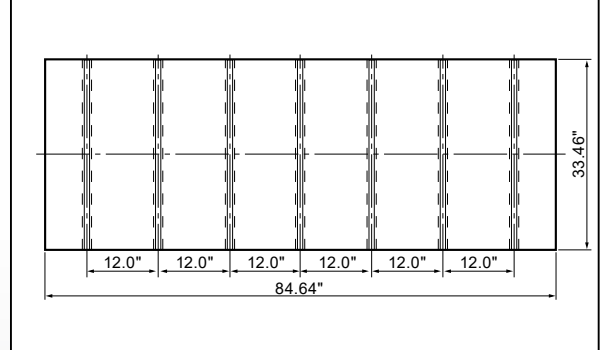
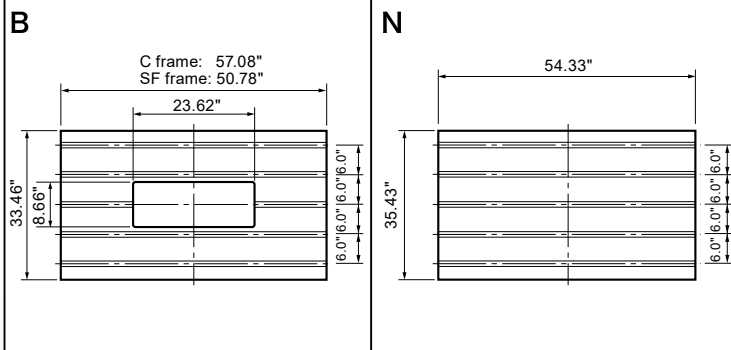

**SDEW-3025i3**

Standard slide bottom drawing

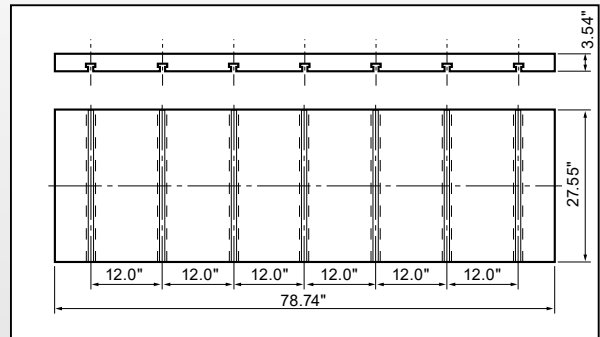

Bolster plate drawing

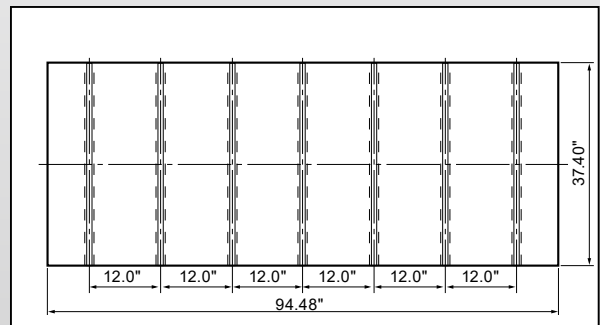

# Specifications and Dimension Drawings

## Machine specifications

Machine model	SDE-8018i3		SDE-1120i3		SDE-1522i3	
Frame type*	C	SF	C	SF	C	SF
Capacity <small>short ton</small>	88		121		165	
Tonnage rating point above BDC	0.188		0.196		0.196	
Side opening**	N/A	19.6 x 17.71	N/A	24.4 x 21.65	N/A	26.77 x 21.25
Continuous no-load stroke rate***	~ 80		~ 70		~ 60	
Stroke length	7.08		7.87		8.85	
Die height	13.77		15.35		16.92	
Slide adjustment	3.15		3.93		3.93	
Slide face dimensions (LR x FB)	21.65 x 17.71		23.62 x 19.68		27.55 x 21.65	
Bolster dimensions (LR x FB x T)	40.55 x 23.62 x 5.31	37.00 x 24.40 x 5.31	43.30 x 27.55 x 5.90	40.55 x 27.55 x 5.31	49.21 x 29.52 x 6.29	45.66 x 29.52 x 6.29
Main motor (AC servo), continuous rating	33.51		40.21		46.91	
Machine mass	16,534	20,943	24,250	28,660	35,273	44,092

Machine model	SDE-2025i3		SDE-3030i3	
Frame type*	C	SF	SF	
Capacity <small>short ton</small>	220		330	
Tonnage rating point above BDC	0.216		0.216	
Side opening**	N/A	30.31 x 23.03	30.31 x 29.52	
Continuous no-load stroke rate***	~ 55		~ 40	
Stroke length	9.84		11.81	
Die height	18.11		21.65	
Slide adjustment	4.33		4.33	
Slide face dimensions (LR x FB)	33.46 x 24.80		43.30 x 29.52	
Bolster dimensions (LR x FB x T)	57.08 x 33.46 x 7.08	50.78 x 33.46 x 7.08	54.33 x 35.43 x 7.87	
Main motor (AC servo), continuous rating	53.61		67.00	
Machine mass	52,910	57,320	85,980	

Machine model	SDEW-2025i3		SDEW-3025i3	
Frame type*	SF		SF	
Capacity <small>short ton</small>	220		330	
Tonnage rating point above BDC	0.216		0.196	
Side opening**	28.34 x 15.74		28.34 x 17.71	
Continuous no-load stroke rate***	~ 50		~ 45	
Stroke length	9.84		9.84	
Die height	19.68		21.65	
Slide adjustment	4.33		4.72	
Slide face dimensions (LR x FB)	68.89 x 25.59		78.74 x 27.55	
Bolster dimensions (LR x FB x T)	84.64 x 33.46 x 7.08		94.48 x 37.40 x 7.87	
Main motor (AC servo), continuous rating	53.61		67	
Machine mass	72,752		99,208	

These specifications, machinery, equipment, and appearance are subject to change without notice for reason of improvement.

\* "C" Gap Frame, "SF" Straght-Side Frame  
 \*\* Side opening is height above bolster top surface.  
 \*\*\* Max stroke length

■ Machine outline dimensions

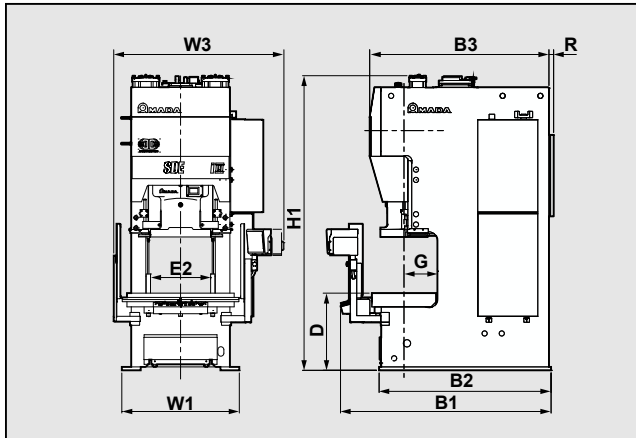

SDE-i3 C frame

Measurement unit = inch

Machine model	SDE-8018i3	SDE-1120i3	SDE-1522i3	SDE-2025i3
W1	42.51	49.21	53.93	60.62
B2	62.40	70.66	78.93	88.77
H1	114.76	121.00	135.23	152.55
D	33.46	33.46	35.43	39.37
E2	20.86	24.00	27.55	31.88
G	12.20	14.17	15.35	17.12
W3	67.12	73.42	78.14	83.85
B1	76.37	89.96	96.65	108.26
B3	63.18	74.60	82.28	92.51
R	7.28	1.50	2.16	1.18

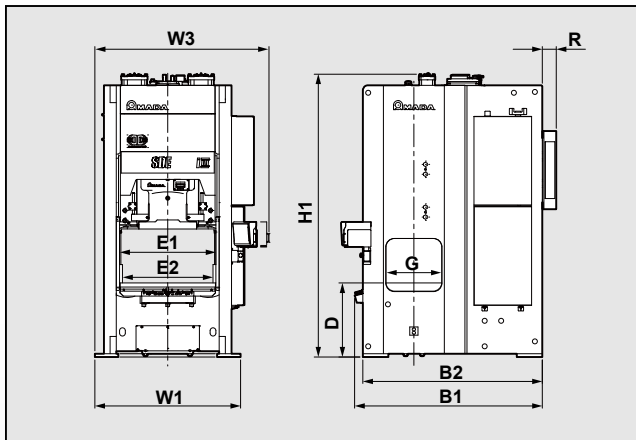

SDE-i3 SF frame

Measurement unit = inch

Machine model	SDE-8018i3	SDE-1120i3	SDE-1522i3	SDE-2025i3	SDE-3030i3
W1	57.08	62.20	69.68	75.59	84.25
B2	68.50	76.37	85.82	92.91	96.45
H1	114.76	121.06	135.23	152.55	177.75
D	33.46	33.46	35.43	39.37	41.53
E1	40.55	44.09	46.06	51.18	55.11
E2	34.64	38.18	43.30	47.36	52.36
G	19.68	24.40	26.77	30.31	30.31
W3	70.66	72.63	79.92	84.84	92.12
B1	75.98	85.03	89.76	95.07	-----
R	7.08	1.96	6.69	10.23	20.47

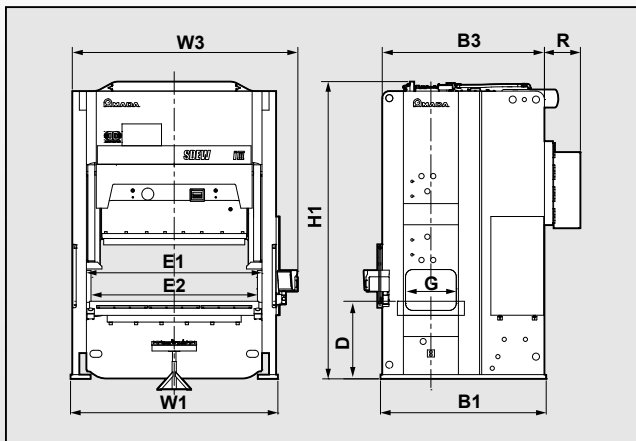

SDEW-i3 SF frame

Measurement unit = inch

Machine model	SDEW-2025i3	SDEW-3025i3
W1	113.38	115.74
B1	92.51	92.51
H1	148.62	165.94
D	39.37	43.30
E1	84.64	98.03
E2	81.88	91.73
G	28.34	28.34
W3	118.70	131.69
B3	90.55	90.55
R	7.67	20.47

## Machine installation range comparison

Measurement unit = inch				
Size	Machine name	L	W	H
NEW	SDE-2025i3 (SF)	75.59	103.14	152.55
	TP-200EX (Drawing type)	60.62	88.77	152.55
NEW	SDEW-3025i3 (SF)	115.74	110.62	165.94
	TPWL-300 (SF)	115.74	98.03	165.94

\*This illustration compares the installation area of the servo stamping press machines with conventional machines (blue/pink lines).

## Standard accessories

- Large color LCD display
- Die information for 100 dies
- Total counter × 2
- Preset counter × 2
- Position switch × 4
- Overload protector
- Air ejector
- Built-in load monitor
- Auto slide adjustment
- Vibration isolator
- Built-in die protection system
- Micro pulse motion

## Optional accessories

- Automation compatible
- Die lifter
- Automatic clamp
- Side guard
- Rear guard
- Handwheel
- Light curtain (Front)
- Light curtain (Rear)\*

\*SDEW-i3 type only

## Specifications of digital die cushion as option

Machine name	SDE-8018i3		SDE-1120i3		SDE-1522i3		SDE-2025i3		SDE-3030i3
Frame type	C	SF	C	SF	C	SF	C	SF	SF
Capacity short ton	63	63	75	63	95	75	140	95	140
Stroke length inch	3.14	3.14	3.14	3.14	3.14	3.14	3.93	3.14	3.93
Pad dimensions (LR x FB) inch	18.89 x 11.81	17.71 x 12.00	17.71 x 12.00	17.71 x 12.00	20.07 x 13.58	17.71 x 12.00	25.19 x 17.51	18.89 x 13.58	25.19 x 17.51

Warning: O.S.H.A. - required point of use guards for protecting the operator are not included and are the responsibility of the end user. These items can be purchased as a turn-key option.

This control meets or exceeds the current requirements for press control systems as defined in O.S.H.A. Standards Section 1910.217, paragraphs (b)13 and (b)14 as published in the Federal Register, July 1, 1991 and ANSI B11.1-2009 as interpreted by AMADA PRESS SYSTEM CO., LTD. Compliance with any local code(s) or requirements is the responsibility of the user.

Before using those products, please read the operator's manual carefully and follow all applicable instructions.

- Use of this product requires safeguard measures to suit your work. For details, see the safety guide on the home page.
- The servo presses correspond to the press machines specified in the Ordinance on Industrial Safety and Health. It is necessary to make application for their installation and take any other measure required.
- Options are included in the photos.



\* Specifications, appearance, and equipment are subject to change without notice for improvement and other purposes.

\* The official "Model name" for machines and units listed in this catalogue are SDE8018i3, SDE1120i3, SDE1522i3, SDE2025i3, SDE3030i3, SDEW2025i3, and SDEW3025i3.

\* Use these "Model numbers" when contacting authorities to apply for installation, export, or financing.

\* In this catalogue, if there is a part with a hyphen in it, like "SDE-8018i3," it is for readability.

\* The specifications described in this catalogue are for the North American market. Please ask your sales person for details.

