

FINGER HOLDERS

FINGER HOLDERS, UNIVERSAL HOLDERS & OTHER SPECIAL HOLDERS HAVE BEEN DESIGNED TO ACCOMODATE YOUR NEEDS

Finger holders can accommodate any of the A-, B-, or W-type vacuum fingers, cushion fingers or magnets according to the surface configuration. Universal holders provide a universal ball joint to fit on the vacuum finger or magnet, ensuring easy pick up of an inclined surface. Other special holders are available for use with cushion and vacuum fingers.

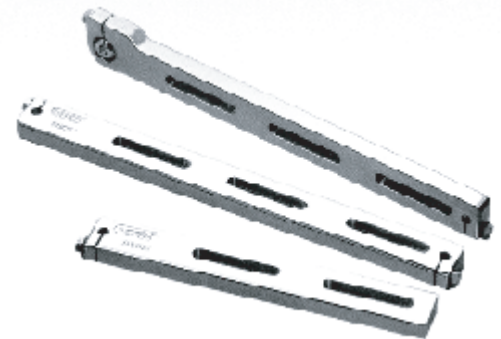

Vacuum Finger Holders

Vacuum finger holders are available in 7 length (Max. 350mm) and free length if required.

Model	Parts No.	Length
YCHA075	T5366	75 mm (2.95")
YCHA115	T5367	115 mm (4.52")
YCHA145	T5368	145 mm (5.70")
YCHA185	T5369	185 mm (7.28")
YCHA210	T5370	210 mm (8.26")
YCHA260	T5371	260 mm (10.23")
YCHA350	T5372	350 mm (13.77")

Material: Alluminum Alloy

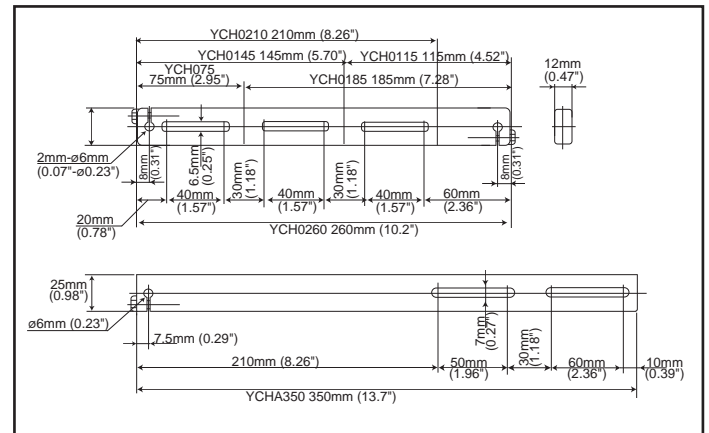

Special Finger Holder

The special finger holder provides 2 X bored holes of $\phi 6\text{mm}$ and $\phi 16\text{mm}$ at both ends on the Finger Holder-16.

Model	Parts No.
YCHB260	T5389

Material: Alluminum Alloy

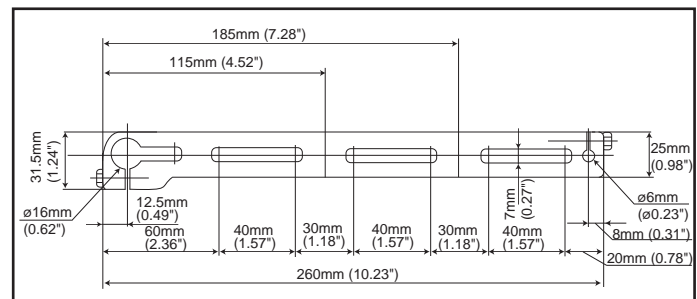

An industry leader in pressroom automation for more than 30 years, Oriimec provides robots, transfer systems, coil handling equipment and straightener/feeder combination units to customers worldwide. Manufactured in Japan, the Orii line of equipment is engineered to meet the specific needs of each of our customers. All Orii products sold in the U.S. are paired with expert service and technical support from our Erlanger, KY office.



Oriimec Corporation of America
1840 Airport Exchange Blvd. #200
Erlanger, KY 41018
U.S.A

Phone:
888.746.3320 (toll free)

Tel: 859.746.3318
Fax: 859.746.3319
Email: info@oriimec.com
Website: www.oriimec.com

FINGER HOLDERS

Magnet Holders

Magnet Holder provides insulator-bush for detecting the workpiece as illustrated below.

Model	Parts. No.	Length
YCHM075	T5373	75 mm (2.95")
YCHM115	T5374	115 mm (4.52")
YCHM145	T5375	145 mm (5.70")
YCHM185	T5376	185 mm (7.28")
YCHM210	T5377	210 mm (8.26")
YCHM260	T5378	260 mm (10.23")
YCHM350	T5379	350 mm (13.77")

Material: Alluminum Alloy

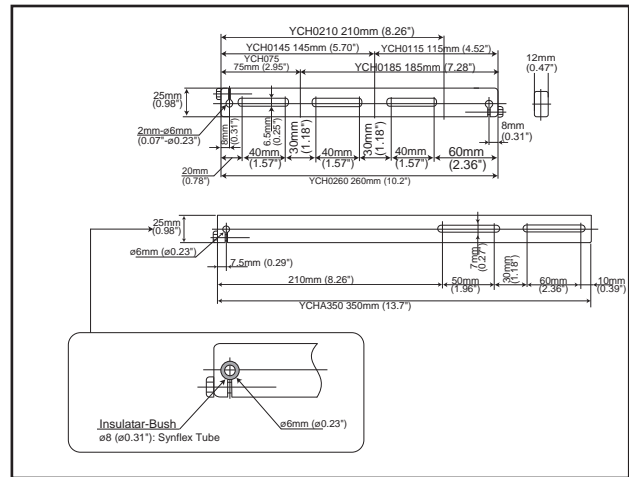

Universal Holders

Universal Holders provide a universal ball joint to fit on a vacuum finger or magnet, ensuring easy pick up on an inclined surface.

Model	Parts. No.	L	A	B	C
YCHU145	T5380	145 mm (5.70")	20 mm (0.78")	35 mm (1.37")	45 mm (1.77")
YCHU220	T5381	220 mm (8.66")	130 mm (5.11")	0 mm (0.0")	50 mm (1.96")
YCHU355	T5382	355 mm (13.97")	230 mm (9.05")	35 mm (1.37")	45 mm (1.77")

Material: Alluminum Alloy

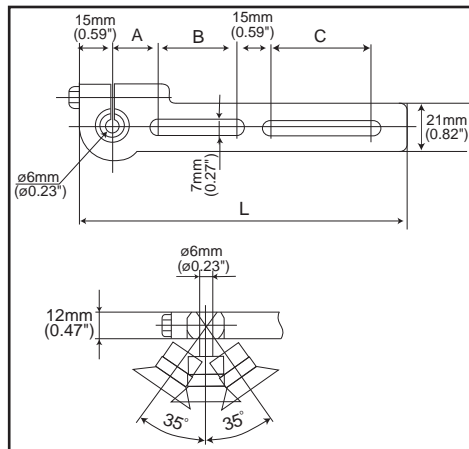

Special Universal Holder

The Special Universal Holder provides 2 X bored holes of $\phi 6\text{mm}$ at both ends on the Finger Holder-16.

Model	Parts. No.
YCHU260	T5425

Material: Alluminum Alloy

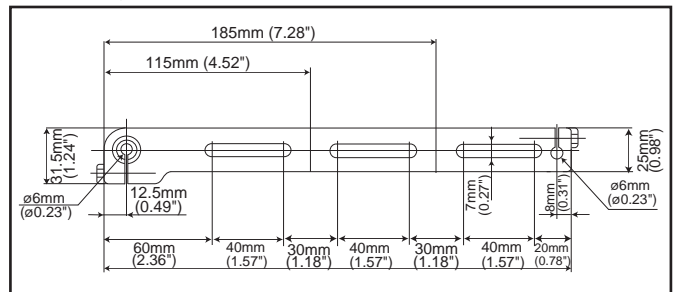

An industry leader in pressroom automation for more than 30 years, Oriimec provides robots, transfer systems, coil handling equipment and straightener/feeder combination units to customers worldwide. Manufactured in Japan, the Orii line of equipment is engineered to meet the specific needs of each of our customers. All Orii products sold in the U.S. are paired with expert service and technical support from our Erlanger, KY office.



Oriimec Corporation of America
1840 Airport Exchange Blvd. #200
Erlanger, KY 41018
U.S.A

Phone:
888.746.3320 (toll free)

Tel: 859.746.3318
Fax: 859.746.3319
Email: info@oriimec.com
Website: www.oriimec.com

FINGER HOLDERS

Cushion Finger Holders

Cushion finger holders are used with a cushion finger with a neck diameter of 16 mm.

Model	Parts No.	L	A	B	C
YCHC145	T5386	145 mm (5.70")	20 mm (0.78")	35 mm (1.37")	45 mm (1.77")
YCHC220	T5387	220 mm (8.66")	135 mm (5.31")	0 mm (0.0")	50 mm (1.96")
YCHC355	T5388	355 mm (13.97")	230 mm (9.05")	35 mm (1.37")	45 mm (1.77")

Material: Alluminum Alloy

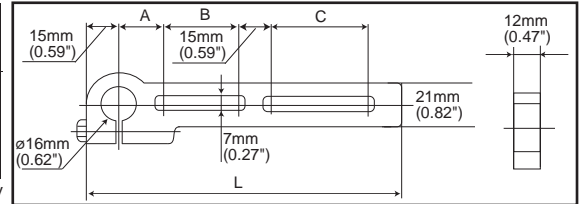

Finger Holder-16

The Finger Holder-16 is used with B-type vacuum finger or cushion finger with a neck diameter of 16mm. Thus, the height may be reduced by sinking an air hose inside the groove of the holder.

Model	Parts No.	L	A
YCHB090	T5383	90 mm (3.54")	30 mm (1.18")
YCHB120	T5384	120 mm (4.72")	60 mm (2.36")
YCHB170	T5385	170 mm (6.69")	110 mm (4.33")

Material: Alluminum Alloy

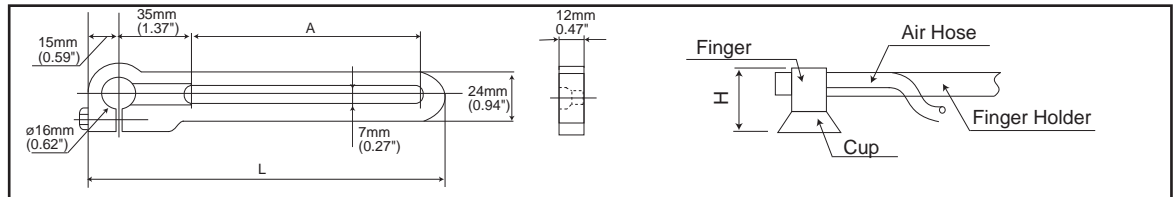

Unit Holders

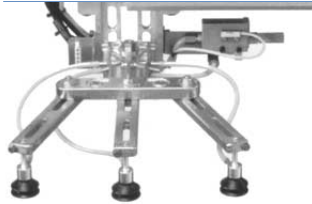

Unit holders are used to mount a number of holders, as required.

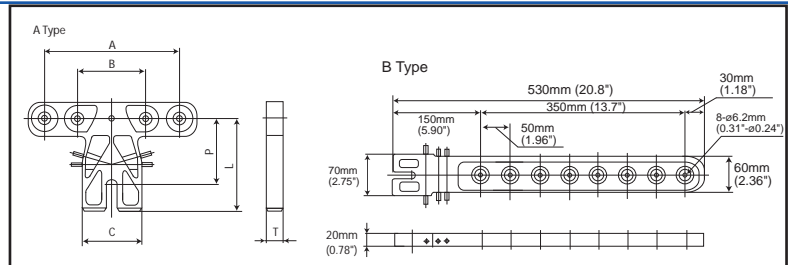

Model	Parts No.	A	B	C	P	L	T	Type	Application
YCU10A	T5391	130mm (5.11")	70mm (2.75")	50mm (1.96")	50mm (1.96")	80mm (3.14")	16mm (0.62")	A	RY80,100
YCU10B	T5392	130mm (5.11")	70mm (2.75")	50mm (1.96")	90mm (3.54")	120mm (4.72")	16mm (0.62")		RY80,100
YCU12A	T5394	160mm (6.29")	80mm (3.14")	70mm (2.75")	80mm (3.14")	110mm (4.33")	20mm (0.78")		RY120
YCU12B	T5394	160mm (6.29")	80mm (3.14")	70mm (2.75")	150mm (5.90")	180mm (7.08")	20mm (0.78")		RY120
YCU05A	T5410	75mm (2.95")	40mm (1.57")	35mm (1.37")	50mm (1.96")	70mm (2.75")	12mm (0.47")		RAW45
YCU05B	T5411	75mm (2.95")	40mm (1.57")	35mm (1.37")	90mm (3.54")	110mm (4.33")	12mm (0.47")		RAW45
YCU20A	T1-2274A	-	-	-	-	-	-	B	RYN200,RY120

An industry leader in pressroom automation for more than 30 years, Oriimec provides robots, transfer systems, coil handling equipment and straightener/feeder combination units to customers worldwide. Manufactured in Japan, the Orii line of equipment is engineered to meet the specific needs of each of our customers. All Orii products sold in the U.S. are paired with expert service and technical support from our Erlanger, KY office.

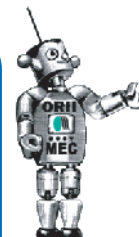

Oriimec Corporation of America
1840 Airport Exchange Blvd. #200
Erlanger, KY 41018
U.S.A.

Phone: 888.746.3320 (toll free)

Tel: 859.746.3318
Fax: 859.746.3319
Email: info@oriimec.com
Website: www.oriimec.com